

### Kit 1

Shower channel CeraFloor Pure  
with drain body DallFlex



### Kit 2

Shower channel CeraWall Pure  
with drain body DallFlex



PURE

Complete shower channel kits  
with **DallFlex** drain body

*DallFlex. Much more than just a drain body:  
a complete system for different  
shower channels*



# Shower channels with **DallFlex** drain body

## The detail makes the difference



### Special characteristics:

- Installation in the screed, can be freely positioned against the wall or in the floor, depending on preference
- Universal drain body with removable trap insert and unique click-in sealing sleeve
- Lengths: 900, 1000, 1200 mm



Flexible sealing sleeve for bonded waterproofing as per DIN 18534 and liquid waterproofing

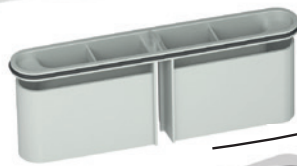

Easy-to-remove trap insert for quick cleaning; easy access to wastewater pipe

180°

Asymmetrical interchangeable frame for adaptation to various wall covering thicknesses from 12 – 32 mm, even after installation in the screed

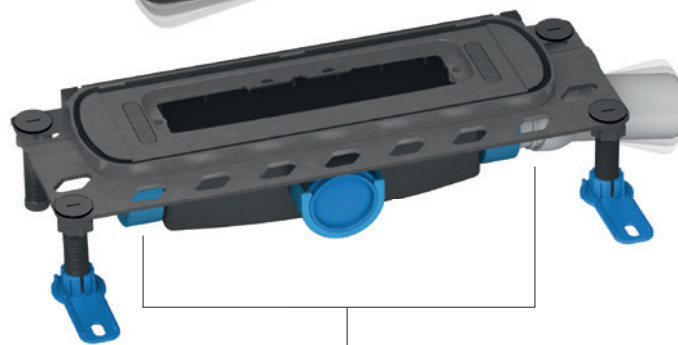
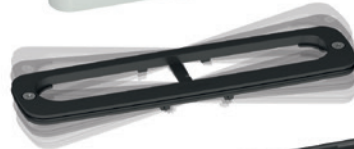

Mounting stands for acoustic decoupling and height adjustment

Tool-free positioning of drain outlet on three sides, moving ball joint for stressfree connection to the wastewater pipe

### Technical information

	BUILD-IN HEIGHTS	DRAINAGE RATES
DallFlex	90 mm	0.8 l/s
DallFlex Plan	65 mm	0.5 l/s

# Kit 1: Installation example for **CeraFloor Pure** shower channel with **DallFlex** drain body when installed flush-in-floor

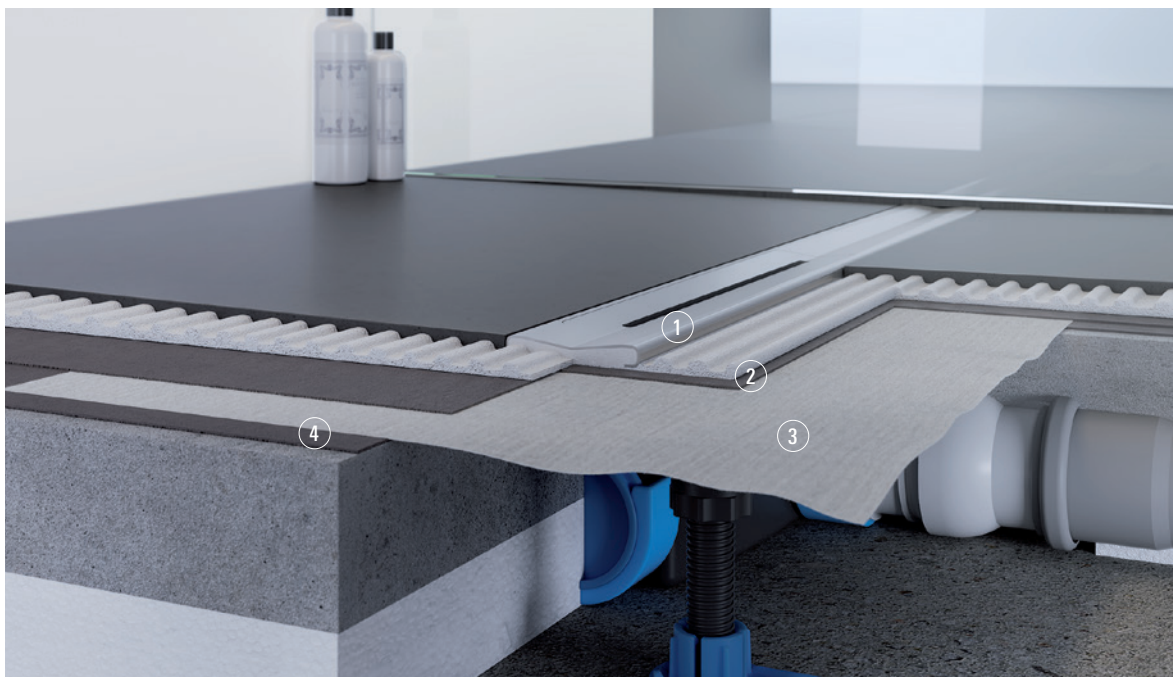

1. 1.5 mm sloped stainless steel
2. Void-free laying in the adhesive bed
3. DallFlex sealing sleeve
4. Bonded waterproofing

## INSTALLATION IN 3 STEPS:

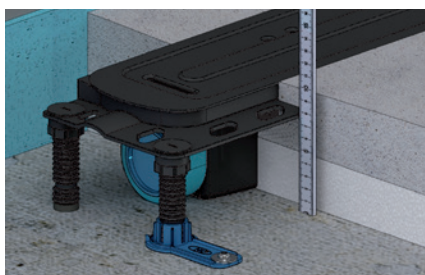

1. Insert the drain body into the screed

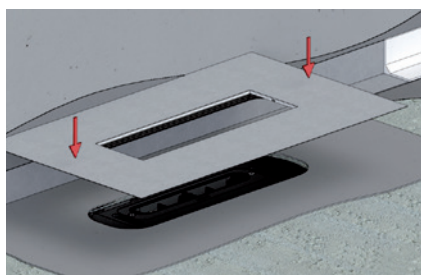

2. Fasten the sealing sleeve with a click on the drain body, then seal off against water



3. Insert the shower channel into the adhesive (like a tile)

## SIMPLE CLEANING:



Rinse off with warm water



Our service for you:  
[www.dallmer.com/en/installation-videos](http://www.dallmer.com/en/installation-videos)

At [dallmer.com](http://dallmer.com) you will find an installation video showing you how easy CeraFloor and DallFlex are to install.

# Kit 1: Shower channel CeraFloor Pure with drain body DallFlex, for installation anywhere in the shower area

## DALLMER Shower channel CeraFloor Pure

Drainage strip with integrated transverse fall, flush-mounted in the shower area. Suitable for floor finish of 12 – 32 mm and wall finish of 12 – 24 mm (including adhesive), length can be adjusted by one millimeter.

## SPECIFICATION

- Cover plate
- Accessories for installation and positioning
- Temporary blanking plate

## MATERIAL

304 stainless steel, 1.5 mm, load class K 3 (300 kg)

## DALLMER Drain body DallFlex

Conforming to DIN EN 1253

Outlet DN 50 horizontal, can be positioned on three sides without tools, with ball-joint, adjustable 0 – 15 degrees. Build-in height 90 mm, removable trap insert with 50 mm water seal.

## DALLMER Drain body DallFlex Plan

Outlet DN 40 horizontal, can be positioned on three sides without tools, with ball-joint, adjustable 0 – 15 degrees. Build-in height 65 mm, removable trap insert with 30 mm water seal.

## SPECIFICATION

- Integrated anchors for extra grip in the screed
- Flexible sealing collar for secure bonding of under-tile waterproofing
- Accessories for sound insulated installation
- Sound absorbing and height adjustable levelling legs
- Removable trap insert
- Temporary blanking plate

## MATERIAL

Drain body polypropylene, outlet DN 50 polypropylene, outlet DN 40 polyethylene

### FLOW RATE TESTED TO DIN EN 1253 (with 20 mm water over cover plate)

	Required	Dallmer
DN 50	0.8 l/s	0.8 l/s

### BUILD-IN HEIGHT DRAIN BODY: 90 MM

ITEM	PART NO.
Shower channel kit CeraFloor Pure, DN 50, 900 mm	539496
Shower channel kit CeraFloor Pure, DN 50, 1000 mm	539878
Shower channel kit CeraFloor Pure, DN 50, 1200 mm	539885

### BUILD-IN HEIGHT DRAIN BODY: 65 MM

ITEM	PART NO.
Shower channel kit CeraFloor Pure Plan, DN 40, 900 mm	539922
Shower channel kit CeraFloor Pure Plan, DN 40, 1000 mm	539939
Shower channel kit CeraFloor Pure Plan, DN 40, 1200 mm	539946



Shower channel CeraFloor Pure



Drain body DallFlex

Build-in height 65 or 90 mm

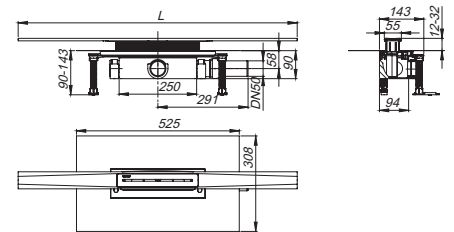

Shower channel kit CeraFloor Pure, DN 50

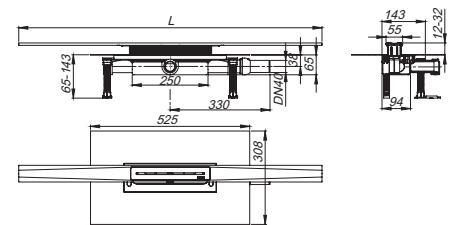

Shower channel kit CeraFloor Pure Plan, DN 40

## Kit 2: Installation example for **CeraWall Pure** with **DallFlex** drain body when installed on the wall



1. 1.5 mm sloped stainless steel
2. Void-free laying in the adhesive bed
3. Bonded waterproofing
4. Self-adhesive sound insulation
5. DallFlex sealing sleeve

### INSTALLATION IN 3 STEPS:

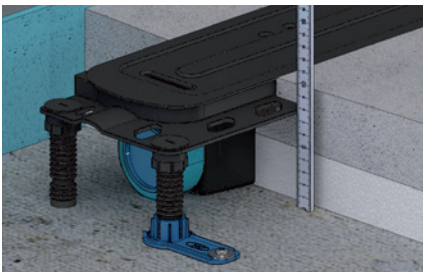

1. Insert the drain body into the screed

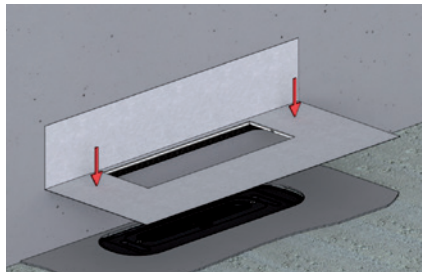

2. Fasten the sealing sleeve with a click on the drain body, then seal off against water

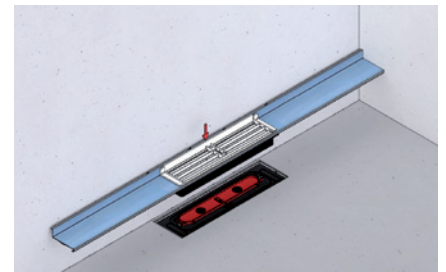

3. Insert the shower channel into the adhesive (like a tile)

### SIMPLE CLEANING:



Rinse off with warm water



Our service for you:  
[www.dallmer.com/en/installation-videos](http://www.dallmer.com/en/installation-videos)

At [dallmer.com](http://dallmer.com) you will find an installation video showing you how easy CeraWall and DallFlex are to install.

# Kit 2: Shower channel CeraWall Pure with drain body DallFlex, for installation against the wall

## DALLMER Shower channel CeraWall Pure

Drainage strip with integrated fall, visibly installed at the junction of wall and floor. Suitable for floor finish of 12 – 32 mm and wall finish of 12 – 24 mm (including adhesive), length can be adjusted by one millimeter.

## SPECIFICATION

- Cover plate
- Self-adhesive sound insulating tape
- Accessories for installation and positioning
- Temporary blanking plate

## MATERIAL

304 stainless steel, 1.5 mm, load class K 3 (300 kg)

## DALLMER Drain body DallFlex

Conforming to DIN EN 1253

Outlet DN 50 horizontal, can be positioned on three sides without tools, with ball-joint, adjustable 0 – 15 degrees. Build-in height 90 mm, removable trap insert with 50 mm water seal.

## DALLMER Drain body DallFlex Plan

Outlet DN 40 horizontal, can be positioned on three sides without tools, with ball-joint, adjustable 0 – 15 degrees. Build-in height 65 mm, removable trap insert with 30 mm water seal.

## SPECIFICATION

- Integrated anchors for extra grip in the screed
- Flexible sealing collar for secure bonding of under-tile waterproofing
- Accessories for sound insulated installation
- Sound absorbing and height adjustable levelling legs
- Removable trap insert
- Temporary blanking plate

## MATERIAL

Drain body polypropylene, outlet DN 50 polypropylene, outlet DN 40 polyethylene



Shower channel CeraWall Pure



Drain body DallFlex

Build-in height 65 or 90 mm

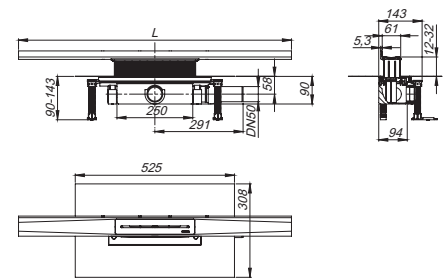

Shower channel kit CeraWall Pure, DN 50

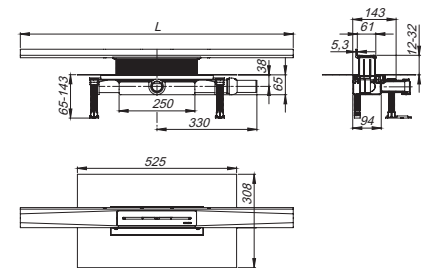

Shower channel kit CeraWall Pure Plan, DN 40

## FLOW RATE TESTED TO DIN EN 1253 (with 20 mm water over cover plate)

	Required	Dallmer
DN 50	0.8 l/s	0.8 l/s

## BUILD-IN HEIGHT DRAIN BODY: 90 MM

ITEM	PART NO.
Shower channel kit CeraWall Pure, DN 50, 900 mm	539892
Shower channel kit CeraWall Pure, DN 50, 1000 mm	539908
Shower channel kit CeraWall Pure, DN 40, 1200 mm	539915

## BUILD-IN HEIGHT DRAIN BODY: 65 MM

ITEM	PART NO.
Shower channel kit CeraWall Pure Plan, DN 40, 900 mm	539953
Shower channel kit CeraWall Pure Plan, DN 40, 1000 mm	539960
Shower channel kit CeraWall Pure Plan, DN 50, 1200 mm	539977

Dallmer Ltd.  
4 Norman Way  
Lavenham, Sudbury  
Suffolk CO10 9PY  
United Kingdom

T +44 1787 248244  
F +44 1787 248246  
E [info@dallmer.com](mailto:info@dallmer.com)  
W [www.dallmer.com](http://www.dallmer.com)